

COMMAND CONTROL ROOM CONSOLE

ELEVATING CONTROL EMPOWERING PRECISION

Welcome to the forefront of command and control with Temas, where innovation meets functionality to redefine the essence of operational excellence. As a leading manufacturer of Command & Control Room Consoles, we pride ourselves on delivering cutting-edge solutions that seamlessly integrate technology, ergonomics, and aesthetics.

At Temas, we understand that the heart of any mission-critical operation lies in its command center. Our commitment is to enhance the efficiency, responsiveness, and overall effectiveness of your control room through state-of-the-art consoles meticulously designed to meet the unique demands of modern operations.

EXPERIENCE THE TEMAS ADVANTAGE

With a legacy of excellence, Temas has become synonymous with quality, innovation, and customer satisfaction. Our commitment goes beyond delivering exceptional products; we are dedicated to forging lasting partnerships with our clients, supporting them through every stage of their operational journey.

Explore the future of command and control with Temas. Elevate your operations, empower your team, and embrace a new standard of excellence.



Precision Engineering

Our consoles are crafted with precision engineering, ensuring durability and reliability in the most demanding environments. From robust materials to intelligent cable management, every detail is considered to withstand the rigors of continuous use.



Ergonomic Excellence

Temas prioritizes the well-being of operators by integrating ergonomic principles into our console designs. Adjustable heights, adaptable layouts, and thoughtfully placed controls ensure a comfortable and efficient workspace, reducing operator fatigue and enhancing productivity.



Technology Integration

Stay ahead in the digital age with seamlessly integrated technology. Temas consoles are designed to accommodate the latest advancements in communication systems, data sources, and connectivity, providing your team with the tools they need for swift decision-making.



Customization Options

Recognizing the diverse needs of our clients, Temas offers a range of customization solutions. Tailor the look and feel of your command center to reflect your organization's aesthetics, creating a space that aligns perfectly with your organization's identity.

- **Defense and Security:**

Enhance mission-critical operations with consoles designed for defense and security command centers.

- **Energy and Utilities:**

Optimize control rooms in energy and utility facilities for efficient monitoring and response.

- **Transportation and Logistics:**

Streamline operations in transportation hubs with consoles that facilitate real-time decision-making.

- **Emergency Services:**

Equip emergency service command centers with advanced consoles for swift and coordinated responses.

- **Telecommunications:**

Enhance network operations with control room consoles tailored for the telecommunications industry.

- **Information Technology (IT):**

Support IT operations with consoles designed for managing data centers and network infrastructure.

- **Smart Cities:**

Contribute to the development of smart cities by providing control room solutions for urban infrastructure management.

- **Aviation:**

Ensure air traffic control centers operate efficiently with consoles designed for aviation control rooms.

- **Environmental Monitoring:**

Contribute to environmental management by providing consoles for monitoring and controlling environmental data.

- **Broadcasting and Media:**

Support broadcasting operations with consoles designed for media control rooms.

- **Space Exploration:**

Contribute to space exploration efforts with specialized consoles for monitoring and controlling space missions.

- **Research and Development:**

Facilitate research endeavors by providing consoles for research and development control centers.

- **Critical Infrastructure:**

Safeguard critical infrastructure by offering consoles designed for monitoring and managing key facilities.

- **Mining:**

Enhance safety and efficiency in mining operations with consoles tailored for control rooms.

OUR PROCESS



Unlock Precision

Experience a tailored approach to command center excellence with Temas. Our expert consultations ensure your Control Room Consoles are customized for peak performance. From ergonomic design to cutting-edge technology integration, trust Temas to elevate your operations.



Designing Excellence

At Temas, we redefine the art of command and control room console design. Every detail is a brushstroke of precision, fusing ergonomic mastery with aesthetic appeal. Our consoles seamlessly integrate form and function, creating an operational masterpiece. Elevate your workspace with Temas where design meets unparalleled performance.



Crafting Perfection

Step into the heart of innovation at Temas Manufacturing, where cutting-edge technology converges with meticulous craftsmanship. Our command and control room consoles are born from a commitment to precision and durability, ensuring a seamless fusion of functionality and reliability. Trust Temas where manufacturing excellence meets operational supremacy.

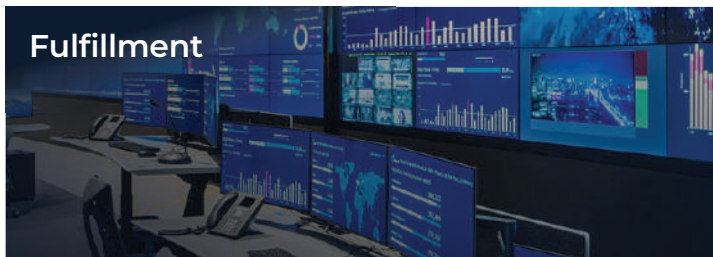

Fulfilling Your Vision

At Temas, we go beyond delivering consoles; we fulfill your vision of command and control excellence. Our commitment to meticulous craftsmanship, advanced technology, and personalized solutions ensures your operational needs are not just met but surpassed. Experience fulfillment with Temas where your success is



 FUSION FLOW

FUSION FLOW

Fusion Flow

Where Innovation Meets Ergonomic Excellence.

Engineered for unparalleled ergonomic adaptability, this cutting-edge console seamlessly integrates dynamic height adjustment, empowering operators to tailor their workspace for optimal comfort and productivity. With precision engineering, customizable design options, and advanced technology integration, this console represents a new standard in command center excellence.

Elevate your operations, prioritize operator well-being, and embrace the future of control room efficiency with the Temas Height Adjustable Console.

Advantages



Operator-Centric Configuration



Versatile Design for Critical Environments



Durable and Professional Worksurface



Smart Cable Management System



Tailored to Your Needs

easy installation



Complete setup effortlessly with a simple and quick assembly design. Its modular structure allows fast deployment with minimal tools, so you can start using it right away without delays.



Motorized Height Adjustment

Command your workspace with precision using our console's height adjustment button. Effortlessly customize your setup, promoting ergonomic comfort and enhancing operational focus. Elevate your control experience with the touch of a button.



Customizable Monitor Arm Configurations

Tailor the Apex Control Console to meet the specific requirements of your command center. Choose from a variety of configurations, including monitor arrangements, accessory integration, and color options. Our customizable solutions empower you to create a workspace that aligns perfectly with your operational needs.

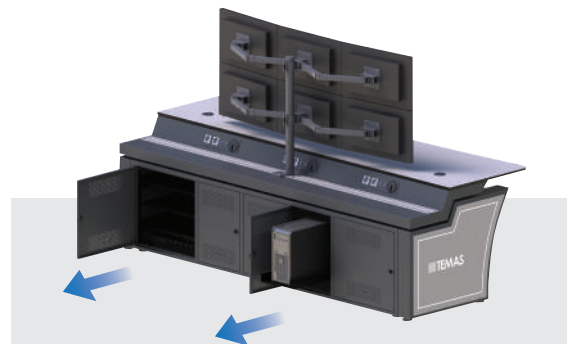

Integrated Rack Cabinet

Maximize efficiency with featuring a seamlessly integrated rack cabinet. Streamline your workspace, organize critical equipment, and boost operational performance. Elevate your operational capabilities with a console designed for precision, where every detail contributes to a heightened command experience.

FUSION FLOW



Fusion Flow

Designed for ergonomic adaptability, this console features dynamic height adjustment to enhance operator comfort and efficiency. With customizable design and advanced technology integration, it sets a new benchmark for modern control rooms. Enhance operations, support operator well-being, and experience the future of control room performance with the Temas Console.

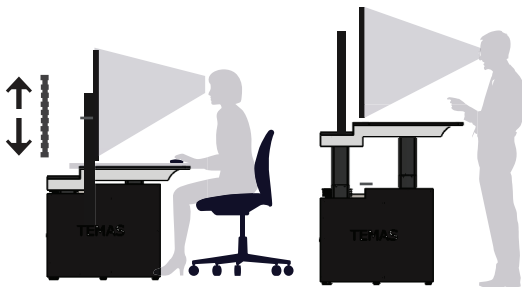

Motorized Height Adjustment

Command your workspace with precision using our console's height adjustment button. Effortlessly customize your setup, promoting ergonomic comfort and enhancing operational focus. Elevate your control experience with the touch of a button.

Ergonomic Comfort
Easily adjust the console height for optimal operator comfort, reducing fatigue during extended use.

Flexibility in Workspace
Seamlessly transition between sitting and standing positions, promoting a dynamic and adaptable work environment.

Health and Well-being
Height adjustment supports the overall health and well-being of operators, reducing the risk of discomfort or strain associated with prolonged periods of sitting.

Personalized User Experience
Tailor the console height to individual preferences, ensuring a customized and ergonomic workspace for every operator.

Enhanced Focus and Productivity
The ability to customize height promotes better focus and productivity by allowing operators to work in a position that suits their needs.

Mobile App Enabled Height Management
With our command and control room consoles, the power to adjust heights isn't just at your fingertips—it's in your pocket. Remotely manage console heights via a user-friendly mobile app, offering operators unparalleled convenience and flexibility.

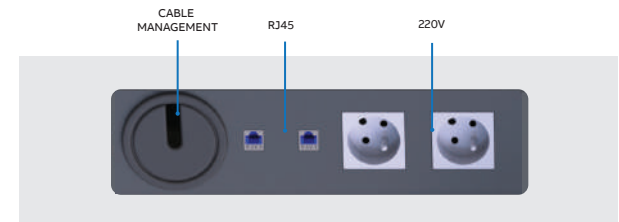

Empowered Connectivity

Our command and control room consoles prioritize connectivity with built-in power and network outlets on the table. Streamline operations by keeping devices powered and connected, ensuring your team stays seamlessly engaged with the information they need.



Wireless Charger

Experience seamless connectivity with our command and control room consoles featuring built-in wireless chargers on the table. Stay powered up effortlessly, ensuring your devices are ready for action at all times.



 LUMINEX

LUMINEX

Luminex

Elegance Meets Functionality

The Luminex Command Control Room Console is meticulously designed to deliver superior ergonomics, advanced functionality, and contemporary aesthetics, perfectly suited for today's demanding mission-critical environments. Every detail has been carefully engineered to support operators who require precision, comfort, and reliability in their daily workflow.

Equipped with a smooth motorized height adjustment system, the console allows users to effortlessly transition between sitting and standing positions throughout the day. This flexibility not only enhances individual comfort but also promotes healthier posture and sustained focus during extended operational periods. The Luminex Console combines performance, adaptability, and modern design offering an ideal solution for control rooms where efficiency and endurance are essential.

Advantages



Operator-Centric Configuration



Versatile Design for Critical Environments



Durable and Professional Workspace



Smart Cable Management System



Tailored to Your Needs

easy installation



Complete setup effortlessly with a simple and quick assembly design. Its modular structure allows fast deployment with minimal tools, so you can start using it right away without delays.

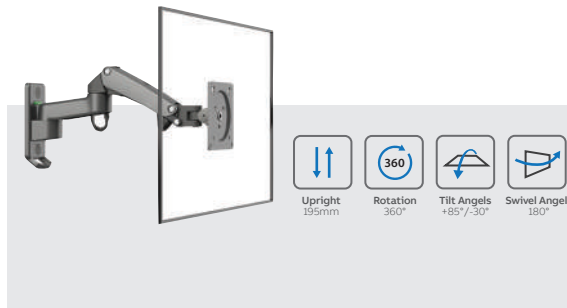

Motorized Height Adjustment

The smooth and silent motorized lifting mechanism ensures effortless transitions between sitting and standing positions, allowing operators to easily adjust their posture at any time. This feature enhances comfort, reduces fatigue, and boosts productivity during long working hours, while its quiet operation helps maintain a calm and focused environment ideal for mission-critical tasks.

Monitor Arm and Sigma Rail System

The top surface features a durable monitor arm bracket securely mounted on a precision-engineered sigma rail, providing smooth, flexible, and stable positioning for multiple monitors. This system allows operators to easily adjust the height, angle, and distance of each screen to suit their individual needs, improve ergonomics, and create an optimized viewing experience for enhanced comfort and efficiency during intensive operations.

Detachable 19" Rack Cabinet

The built-in 19-inch rack cabinet, equipped with durable railed shelves, offers well-organized and secure storage for essential IT and AV equipment. This smart design ensures efficient use of space, enhances system accessibility, and simplifies maintenance tasks. It allows operators and technicians to manage devices neatly while maintaining a clean, professional, and clutter-free workspace for continuous, reliable performance.

LUMINEX



Advantages of the Luminex

Ideal for command and control centers, security monitoring rooms, broadcast studios, traffic management centers, and emergency response facilities, the Luminex is engineered to meet the highest standards of performance and design.



Motorized Height Adjustment

Smooth and silent motorized lifting mechanism allows effortless transition between sitting and standing positions, enhancing operator comfort and productivity.

 Enhances ergonomic comfort.

 Supports sit-stand workstyles for improved productivity.

 Quiet and reliable motor for seamless adjustments.



Compact Laminate Working Surface

Choose from Corian®, acrylic, or compact laminate top surfaces offering durability, hygiene, and a refined aesthetic suitable for 24/7 operations



LED-Illuminated Side Bar with Corporate Logo

A distinctive LED side bar can be customized with your corporate logo, adding a sophisticated and branded visual touch to the control room environment.

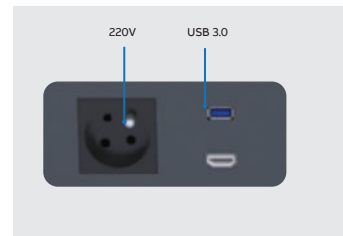

Multimedia Ports

The working surface includes easily accessible multimedia ports such as power outlet, HDMI, USB, and USB-C inputs, enabling seamless connectivity for devices and peripherals.



Wireless Charger

The integrated wireless mobile phone charger keeps personal and work devices powered without cable clutter.



SPACE LIGHT

SPACE LIGHT

Space Light

Apex Control Console: Elevate Control, Elevate Results

Experience unparalleled control and efficiency with our state of the art fixed-height command control room console, the Apex Control Console. Designed to meet the rigorous demands of modern command centers, this console seamlessly blends form and function, offering a superior workspace for operators and decision-makers

Fixed Height for Optimal Ergonomics

The Apex Control Console is engineered with a fixed-height design, ensuring optimal ergonomics for operators. With careful consideration of human factors, the console promotes a comfortable and efficient working environment, reducing operator fatigue during extended use.

Advantages



Operator-Centric Configuration



Versatile Design for Critical Environments



Durable and Professional Workspace



Smart Cable Management System



Tailored to Your Needs

easy installation



Complete setup effortlessly with a simple and quick assembly design. Its modular structure allows fast deployment with minimal tools, so you can start using it right away without delays.

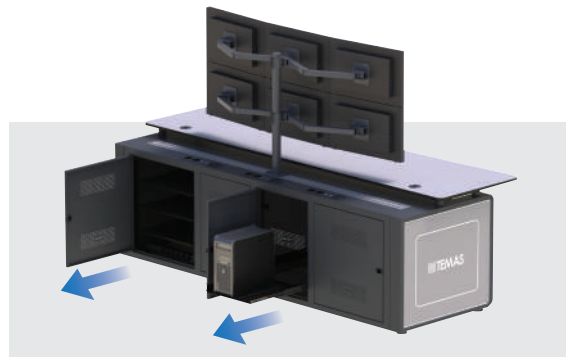

Motorized Height Adjustment

Experience a new era in control room efficiency with our Height Adjustable Command Consoles. Elevate operator well being, boost productivity, and foster a dynamic work environment. Our consoles prioritize ergonomic comfort, adaptability to individual preferences, and contribute to overall health benefits. Revolutionize your control space with the key to enhanced focus and a healthier, more productive team..

Customizable Monitor Arm Configurations

Tailor the Apex Control Console to meet the specific requirements of your command center. Choose from a variety of configurations, including monitor arrangements, accessory integration, and color options. Our customizable solutions empower you to create a workspace that aligns perfectly with your operational needs.

Enhanced Technology Integration

The Space Light control room console offers advanced integration features, supporting seamless connectivity with AV systems, data networks, and control software. It includes integrated power distribution, cable management, and device docking options to ensure efficient workflow and centralized system operation.

SPACE LIGHT



Space Light

Achieve exceptional control and efficiency with our fixed-height command console. Built for the demands of modern command centers, the Apex combines functionality and design to deliver a reliable and efficient workspace for operators and decision-makers.

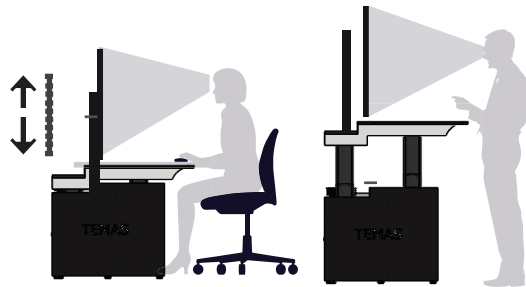

Motorized Height Adjustment

Command your workspace with precision using our console's height adjustment button. Effortlessly customize your setup, promoting ergonomic comfort and enhancing operational focus. Elevate your control experience with the touch of a button.

Ergonomic Comfort

Easily adjust the console height for optimal operator comfort, reducing fatigue during extended use.

Personalized User Experience

Tailor the console height to individual preferences, ensuring a customized and ergonomic workspace for every operator.

Flexibility in Workspace

Seamlessly transition between sitting and standing positions, promoting a dynamic and adaptable work environment.

Enhanced Focus and Productivity

The ability to customize height promotes better focus and productivity by allowing operators to work in a position that suits their needs.

Health and Well-being

Height adjustment supports the overall health and well-being of operators, reducing the risk of discomfort or strain associated with prolonged periods of sitting.

Mobile App Enabled Height Management

With our command and control room consoles, the power to adjust heights isn't just at your fingertips—it's in your pocket. Remotely manage console heights via a user-friendly mobile app, offering operators unparalleled convenience and flexibility.

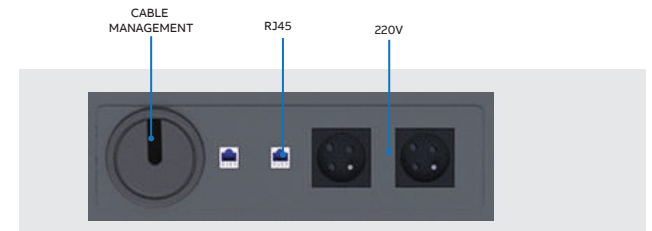

Integrated Multimedia Connectivity

To support a wide range of broadcast and data systems, Space Light features a comprehensive power socket module built into the working surface. Standard configurations include

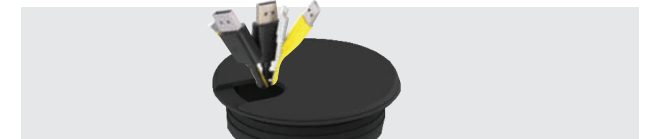

Integrated Cable Management

The console features intelligent cable management solutions, keeping cables organized and out of sight. This not only enhances the aesthetics of your command center but also facilitates easy maintenance and troubleshooting.



 QUANTUM

QUANTUM

Quantum

Designed for versatility

Quantum features height adjustability for ergonomic comfort and offers a range of length options, including 135 cm, 180 cm, and 240 cm, to fit any operational space. This flexibility ensures that users of different heights and working styles can achieve optimal posture, reducing strain during long working hours.

Combining sleek aesthetics with robust functionality, Quantum is the ideal workstation solution for demanding environments, enhancing both productivity and efficiency. Its refined design seamlessly integrates into modern office layouts, while its durable build supports heavy, continuous use without compromising stability. Whether used in collaborative areas or individual workstations, Quantum adapts effortlessly, providing a reliable platform that empowers professionals to perform at their best.

Advantages



easy installation



Complete setup effortlessly with a simple and quick assembly design. Its modular structure allows fast deployment with minimal tools, so you can start using it right away without delays.



Motorized Height Adjustment

Quantum features a smooth motorized height adjustment mechanism, allowing users to effortlessly customize the console height to their preferred ergonomic position. Whether sitting or standing, the console adapts to your needs, promoting better posture and reducing fatigue during long shifts.



Customizable Monitor Arm Configurations

Equipped with a Sigma Rail system, Quantum provides a robust and flexible solution for mounting monitor arms. This feature ensures optimal screen positioning, enabling users to create a multi-monitor setup tailored to their workflow.

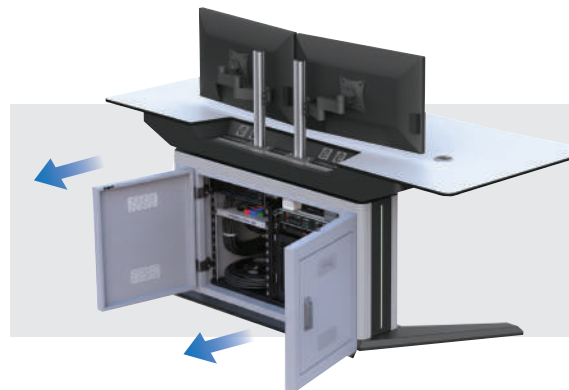

19" 12U Rack Cabinet

Maximize efficiency with Temas command and control room consoles featuring a seamlessly integrated rack cabinet. Streamline your workspace, organize critical equipment, and boost operational performance. Elevate your operational capabilities with a console designed for precision, where every detail contributes to a heightened command experience.

QUANTUM



Advantages of the Quantum

Available in multiple sizes (135, 180, and 240 cm), this workstation offers motorized height adjustment for ergonomic comfort and productivity. A bellow system ensures seamless cable management, while LED side bars add both style and subtle illumination. With Sigma rails for monitor arms, integrated AV storage, and a durable laminate surface, it combines functionality, resilience, and modern design perfect for high-tech command and control rooms.



Motorized Height Adjustment

Effortlessly adjust the podium's height with the Quantum. Use the remote control or mobile app for smooth height customization, ensuring maximum comfort for users of all heights.



Wide Compact Working Surface

Experience enhanced visibility and ambiance with Temas consoles featuring LED-lighted bases. Improve workspace visibility during low-light conditions, maintain a modern aesthetic, and create a professional environment where functionality meets style.



Wireless Charger

Experience seamless connectivity with our command and control room consoles featuring built-in wireless chargers on the table. Stay powered up effortlessly, ensuring your devices are ready for action at all times.

Ergonomic Comfort

Easily adjust the console height for optimal operator comfort, reducing fatigue during extended use.



Personalized User Experience

Tailor the console height to individual preferences, ensuring a customized and ergonomic workspace for every operator.



Flexibility in Workspace

Seamlessly transition between sitting and standing positions, promoting a dynamic and adaptable work environment.

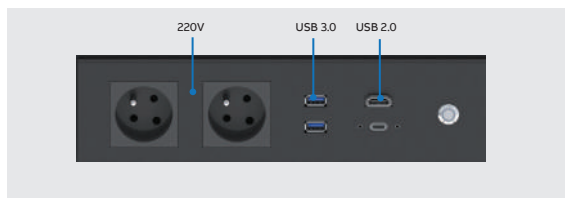

Multimedia Ports

The Quantum is equipped with multimedia ports, including USB, HDMI, and audio jacks, providing seamless connectivity for all your devices. Whether you're connecting monitors, peripherals, or audio equipment, the Quantum has you covered.



 PIXEL SPECTRUM

PIXEL SPECTRUM

Pixel Spectrum

Elevate Control, Elevate Results

Experience unparalleled control and efficiency with our state-of-the-art fixed-height command control room console, the Apex Control Console. Specifically engineered to meet the rigorous demands of modern command centers, this advanced console seamlessly blends form and function, offering a superior and highly organized workspace for operators and decision-makers. With its precision-crafted design, durable structure, and user-focused layout, the Apex Control Console not only enhances workflow efficiency but also ensures long-term reliability and comfort, making it the ultimate solution for mission-critical environments.

Advantages

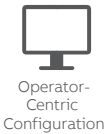

easy installation



Complete setup effortlessly with a simple and quick assembly design. Its modular structure allows fast deployment with minimal tools, so you can start using it right away without delays.

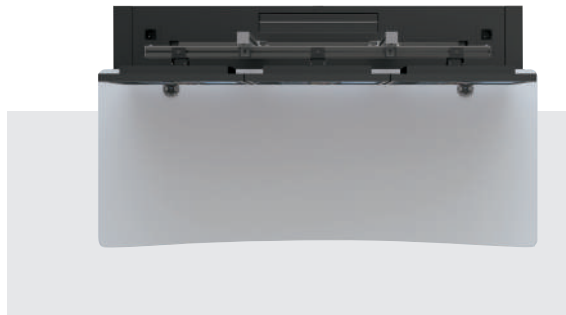

Fixed Height for Optimal Ergonomics

Pixel Spectrum features a smooth motorized height adjustment mechanism, allowing users to effortlessly customize the console height to their preferred ergonomic position. Whether sitting or standing, the console adapts to your needs, promoting better posture and reducing fatigue during long shifts.

Durable Construction

Crafted from high-quality materials, Pixel Spectrum Console is built to withstand the demands of 24/7 mission-critical operations. Its robust construction ensures durability and longevity, providing a reliable platform for your command center needs.

Customizable Monitor Arm Configurations

Choose from a variety of configurations, including monitor arrangements, accessory integration, and color options. Our customizable solutions empower you to create a workspace that aligns perfectly with your operational needs.

PIXEL SPECTRUM



Pixel Spectrum

Experience exceptional control and efficiency with the Apex Control Console a fixed height, state-of-the-art command solution. Designed for modern control rooms, it combines precision engineering, durability, and ergonomic comfort. Its sleek, organized layout enhances workflow and ensures lasting reliability, making it ideal for mission-critical operations.

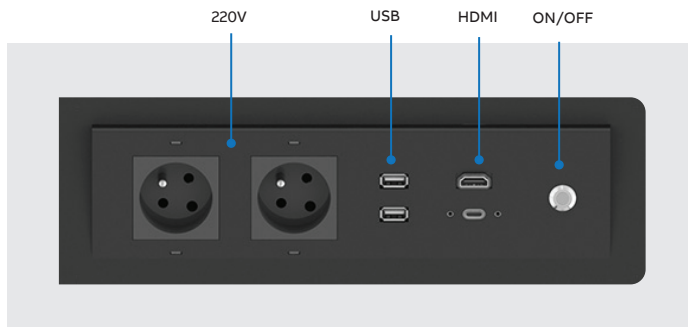

Integrated Cable Management

Pixel Spectrum is equipped with multimedia ports, including USB, HDMI, and audio jacks, providing seamless connectivity for all your devices. Whether you're connecting monitors, peripherals, or audio equipment, the Astro Sync has you covered.



Effortless Installation

Designed with user convenience in mind, the Apex Control Console is easy to install, minimizing downtime during deployment. Our streamlined installation process ensures a quick and efficient setup, allowing your command center to be operational in no time.

Enhanced Technology Integration

Stay at the forefront of technology with seamless integration capabilities. The console accommodates the latest control room equipment, ensuring compatibility with advanced technology and future upgrades.



 ASTRO SYNC

ASTRO SYNC

Astro Sync

Designed for versatility

The Astro Sync is the ultimate motorized height-adjustable console designed for modern control rooms, offering unparalleled flexibility, ergonomic comfort, and cutting-edge functionality. Built to meet the demands of dynamic work environments, the Astro Sync combines sleek design with advanced features, ensuring seamless integration into any workspace. Whether you're managing complex operations or multitasking across multiple monitors, the Astro Sync empowers you to work smarter, faster, and more comfortably.

Why Choose Astro Sync?

The Astro Sync is more than just a console it's a complete workspace solution designed to enhance productivity, comfort, and efficiency in control room environments. With its advanced features, customizable options, and sleek design, the Astro Sync is the perfect choice for professionals who demand the best.

Advantages



Operator-Centric Configuration



Versatile Design for Critical Environments



Durable and Professional Workspace



Smart Cable Management System



Tailored to Your Needs

easy installation



Complete setup effortlessly with a simple and quick assembly design. Its modular structure allows fast deployment with minimal tools, so you can start using it right away without delays.



Motorized Height Adjustment

The Astro Sync features a smooth motorized height adjustment mechanism, allowing users to effortlessly customize the console height to their preferred ergonomic position. Whether sitting or standing, the console adapts to your needs, promoting better posture and reducing fatigue during long shifts.



Customizable Monitor Arm Configurations

Equipped with a Sigma Rail system, the Astro Sync provides a robust and flexible solution for mounting monitor arms. This feature ensures optimal screen positioning, enabling users to create a multi-monitor setup tailored to their workflow.

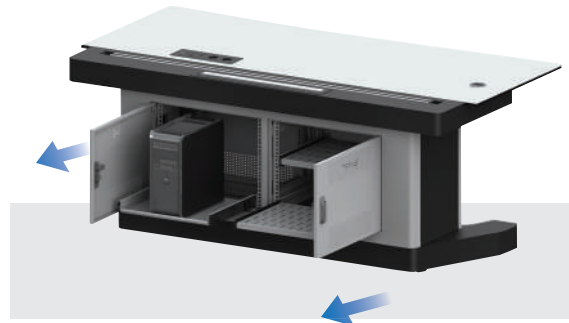

Enhanced Technology Integration

The Astro Sync model features a compact cabinet at the bottom, designed to optimize space without compromising functionality. It's the perfect choice for environments with limited room or when only a few essential electronic components need to be installed inside the console.

ASTRO SYNC



Advantages of the AstroSync

Designed for auditoriums, classrooms, control rooms, and hospitals, this podium combines durability and style with a 12mm laminate surface resistant to scratches, heat, and moisture. Lockable wheels ensure easy mobility, while integrated cable management keeps spaces organized. Fully customizable with options such as touch displays, built-in PC, and branding, it adapts seamlessly to any professional environment.



Motorized Height Adjustment

Command your workspace with precision using our console's height adjustment button. Effortlessly customize your setup, promoting ergonomic comfort and enhancing operational focus. Elevate your control experience with the touch of a button.

 Enhances ergonomic comfort.

 Supports sit-stand workstyles for improved productivity.

 Quiet and reliable motor for seamless adjustments.



Compact Laminate Working Surface

The compact laminate working surface is designed for durability and style. Resistant to scratches, stains, and wear, it provides a sleek and professional finish that complements any control room aesthetic.



Wireless Charger

Experience seamless connectivity with our command and control room consoles featuring built-in wireless chargers on the table. Stay powered up effortlessly, ensuring your devices are ready for action at all times.

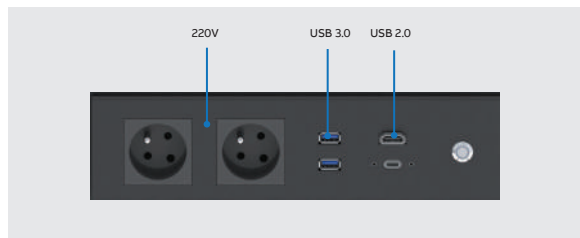

Multimedia Ports

The Astro Sync is equipped with multimedia ports, including USB, HDMI, and audio jacks, providing seamless connectivity for all your devices. Whether you're connecting monitors, peripherals, or audio equipment, the Astro Sync has you covered.



 AUDIOMAX

AUDIOMAX

AV BROADCAST

AudioMax

The AudioMax control room console is a purpose-built, premium grade workstation solution developed specifically for environments that demand reliability, performance, and user-focused ergonomics. Whether in a live broadcast studio, TV control room, network operation center, or industrial process monitoring facility, AudioMax delivers the ideal balance of form and function.

Built on a modular platform, AudioMax offers exceptional versatility and customization. It provides an operator-centric workspace designed to streamline workflow, ensure seamless technology integration, and support 24/7 mission-critical operations.

Advantages



Operator-Centric Configuration



Versatile Design for Critical Environments



Durable and Professional Workspace



Smart Cable Management System



Tailored to Your Needs

easy installation



Complete setup effortlessly with a simple and quick assembly design. Its modular structure allows fast deployment with minimal tools, so you can start using it right away without delays.



Durable 12 mm Compact Laminate Worksurface

The work surface is constructed from high-pressure 12 mm compact laminate a material known for its exceptional durability, impact resistance, and easy-clean surface. Ideal for high traffic control room environments, it delivers a robust and refined finish that stands up to daily operational demands while maintaining a modern aesthetic.



Upright
195mm

Rotation
360°

Tilt Angles
+85°/-30°

Swivel Angles
180°

Customizable Monitor Arm Configurations

Every AudioMax console is designed with customization in mind. Clients can choose from a wide range of sizes, finishes, colors, and accessory options. Whether you require additional equipment bays, unique cable routing paths, or specific socket configurations, our engineering team will tailor the solution to meet your precise operational and aesthetic goals.

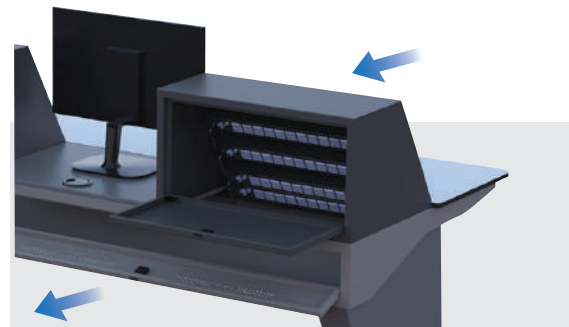

Detachable 19" Rack Cabinet

At the heart of AudioMax is a detachable 19" rack cabinet positioned on the top surface at a 45-degree angle, providing operators with direct, ergonomic access to essential AV and IT equipment. This angled orientation improves visibility and cable accessibility while maintaining a clean, professional workspace.

AUDIOMAX

AV BROADCAST



Audiomax

AudioMax is a premium control room console engineered for reliability, performance, and ergonomic excellence. Ideal for broadcast studios, control rooms, and monitoring centers, it offers the perfect balance of form and function. With its modular design, AudioMax delivers outstanding flexibility and customization creating an operator-focused workspace that enhances workflow, integrates technology seamlessly, and supports 24/7 critical operations.

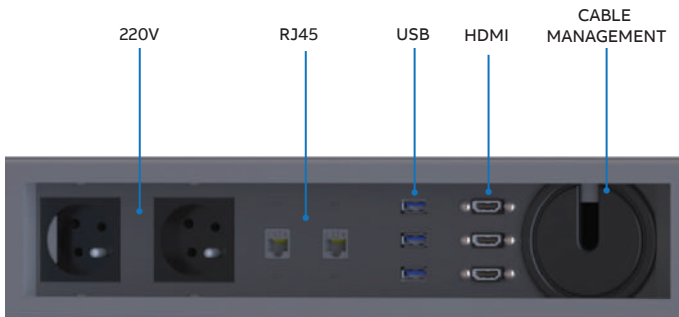

Integrated Multimedia Connectivity

To support a wide range of broadcast and data systems, AudioMax features a comprehensive multimedia socket module built into the working surface. Standard configurations include



LED-Illuminated Logo Panel (Optional)

For clients seeking to reinforce brand identity or enhance the console's visual appeal, an optional LED-backlit logo panel can be integrated into the console base. Fully customizable in terms of color and design, this feature adds a distinctive, high-tech look to any control room setup.

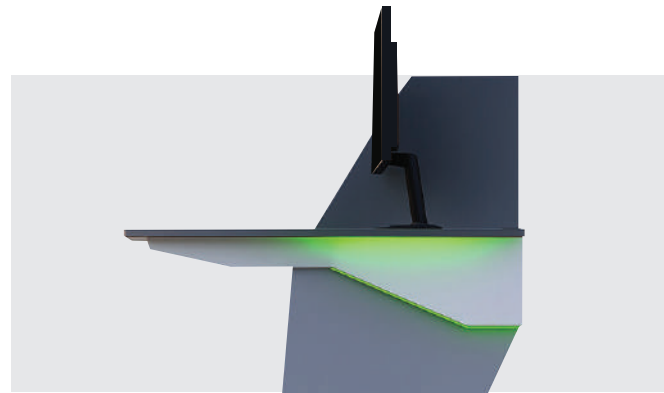

Intelligent Cable Management

Keeping cables organized is critical in high-performance control rooms. AudioMax is equipped with a built-in cable management system that includes:



ACCESSORY

Functional details,
Refined design

OPERATOR CHAIR



Dynamic Back Support

Adopts to shifting back forms and supports waist at every positions. Its flexible structure allows perfect movement during different sitting postures. It can respond to all needs regarding the working chair. With its unique design, Abant offers feeling special to its user. It harmonizes your body, supports your back. With its ergonomic structure, it enables the user to feel always dynamic in the face of intense work that lasts long hours.

Features

- Backrest Mesh, Seat Fabric-Leather
- Seat Made of Polyurethane Moulded Foam
- 3D Aluminium Armrests- Synchrony Plus Mechanism
- Class 4 Gas Lift Cylinder- Luxurious Aluminium Base Ø=68 cm
- Adjustable Seat Depth-
- Adjustable Lumbar Support
- Leather cervical support

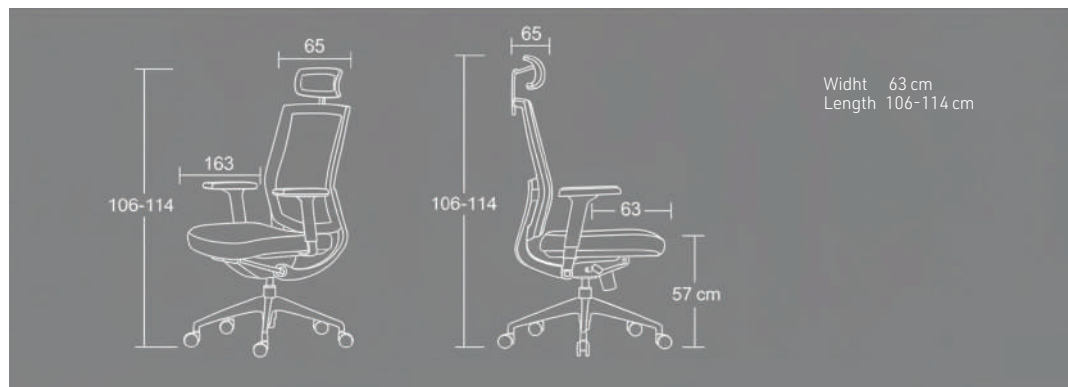

Seat forward-backward movement button



Armrest up and down direction movement



Armrest left and right angular movement



Lumbar support movement

TOWER LIGHTS

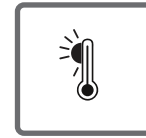
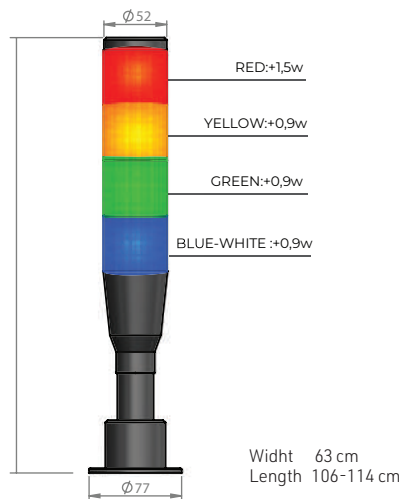
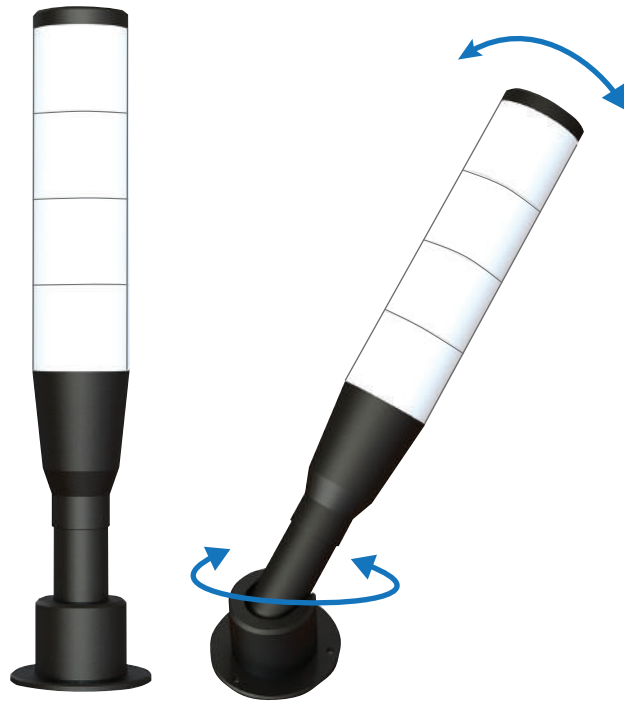

Temperature



High IP value



Shock / Vibration
resistant



Magnetic field
proof



SMD
LED Light

Tower Signal Light for Command & Control Consoles Enhanced Visibility. Improved Safety. Real-Time Status at a Glance.

Designed specifically for mission-critical environments, our Tower Signal Light integrates seamlessly into command control room consoles to provide instant visual and audible status notifications. Whether for operators, technicians, or supervisors, this compact yet powerful signal tower helps monitor system states from a distance—ensuring faster response times, improved workflow efficiency, and heightened operational safety.

Features

- Dual Light Modes: Flashing or steady illumination for flexible signaling
- Broad Voltage Compatibility: Supports (2035 VAC) or (75~285 VAC) input ranges
- Powerful Buzzer Options: Fixed 90 dB or adjustable 50~90 dB sound levels
- Color Customization: Available in red, orange, green, blue, yellow, and clear lenses
- Durable Build: Impact-resistant polycarbonate lenses and ABS housing
- Flexible Configuration: Up to 6 stackable tiers with or without buzzer
- High Visibility: 53 mm lens diameter with 80 flashes per minute
- IP Protection: IP65 rated (IP50 with buzzer) for reliable indoor performance
- Wide Environmental Tolerance: Operates in -20°C to 70°C with 45~85% humidity
- Vibration Resistance: Engineered for stability in 10~55Hz environments
- This tower light is a smart safety enhancement for your consoles, providing a clear, real-time indication of system status and alerts in control rooms, monitoring stations, and industrial

MONITOR ARMS

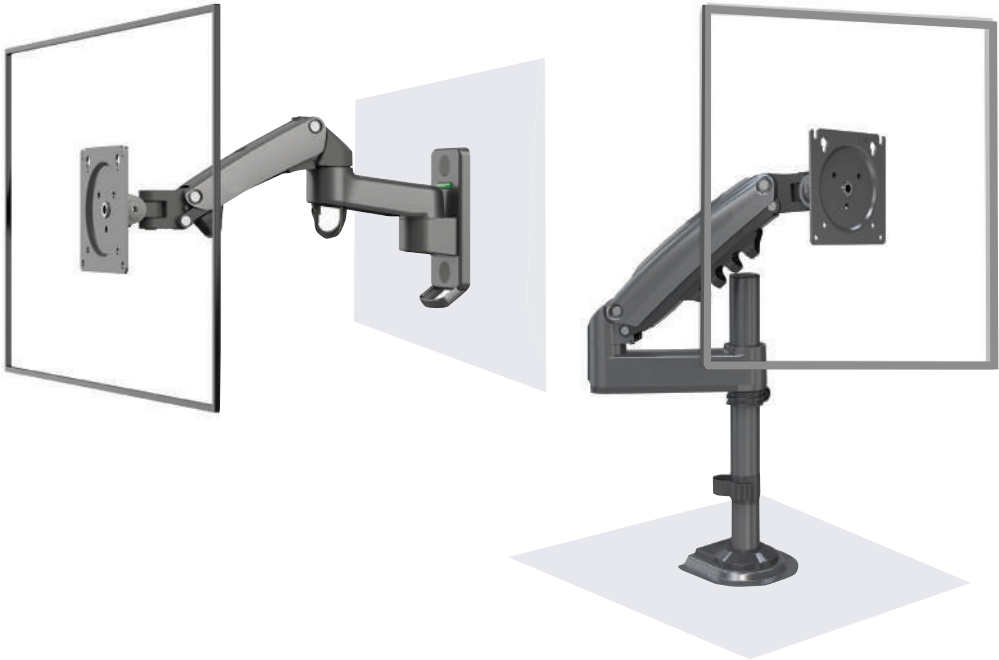

Commercial Grade Monitor Arms

Commercial Grade Monitor Arms
Our commercial-grade monitor arms are designed for 24/7 control room operation, offering strength, precision, and ergonomic flexibility. Made from durable aluminum alloy, they allow smooth tilt, swivel, rotation, and height adjustment for optimal viewing comfort. An integrated cable management system keeps the workspace organized, while VESA compatibility ensures seamless integration with any console setup.

Key Features:

- Heavy-duty construction for continuous use
- Full motion adjustment for perfect positioning
- Integrated cable management
- Stable mounting for single or multi-monitor setups.

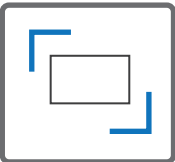

Screen Size
17" - 35"



Capacity
3-12Kg

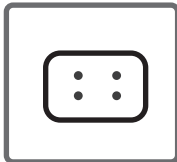

Capacity
3-12Kg

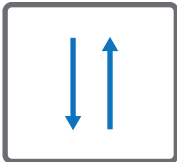

Upright
195mm



Rotation
360°

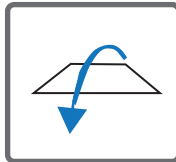

Tilt Angles
+85°/-30°

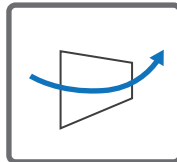

Swivel Angles
180°

FILING CABINETS



Filing Cabinet Durable. Secure. Ergonomic

Enhance your control room workspace with our high-quality filing cabinets, designed to integrate seamlessly with our advanced control room consoles. These cabinets not only provide exceptional durability and functionality but also contribute to a clean, organized, and professional environment. Ideal for storing operational manuals, sensitive documents, and everyday files, they help ensure that important materials are always within easy reach.

With their sleek design and ergonomic build, our filing cabinets enhance both the efficiency and aesthetic appeal of your control room, supporting smooth operations and long-term productivity..

Key Features:

- **Sturdy Construction:** Cold-rolled steel with powder-coated finish.
- **Security:** Lockable drawers with master key option.
- **Weight Capacity:** Each drawer holds up to 40 kg.
- **Dimensions (Standard):** 1980 x 920 x 430 mm (custom sizes available).
- **Finish Options:** Standard black or grey; custom colors on request.

PEDESTAL

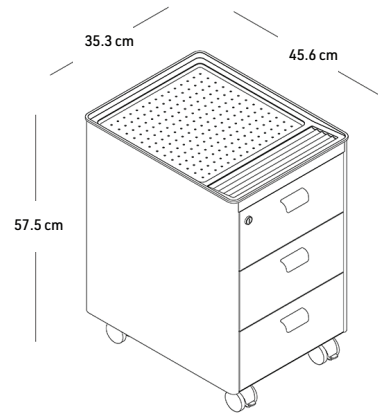

Stylish and Functional Storage Solution

Blending aesthetics and functionality, Pal pedestal makes space on your desk by allowing you to position stationery on its top thanks to its specially designed plastic crown. With the sheet metal panel located on sides of the body with 5 different color alternatives, it offers a stylish storage solution in both office and home work environments.

Trunk Features

Half of the castors are lockable swivel types, and half are non-lockable. The top's special plastic crown holds stationery, while bent sheet metal sides give the body a sleek look with inset drawers.

Frame Support Profile

Box profile is used.

Backrest

Tray is made of 18 mm chipboard, melamine resin impregnated decor paper on both sides (Melamine)**

Drawer Safe

The drawer's internal frame is made of ABS plastic, molded by injecting melted material into hardened steel molds. Its partitions allow attaching dividers, pen holders, and card indexes.

Lock System

Central lock is used.

Lapel

2mm PVC edgeband is used.

Tray is made of 18 mm chipboard, melamine resin impregnated decor paper on both sides (Melamine)**

Sheet Body (1,2mm)

After laser cutting and drilling, sheet metal is bent and welded if required. It's then coated with electrostatic powder or chrome plating. Metal parts go through phosphating, degreasing, and automated powder coating. The four-tank immersion ensures a minimum 40 µ coating, except at corners or inner areas.

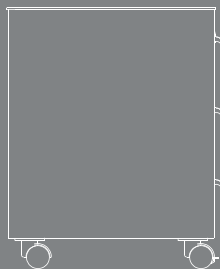
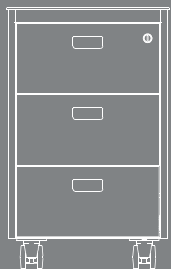

Width 45.6 cm
Length 35.3 cm

Height 57.5 cm
Weight 16.1 kg



Europe

Temas Technology Co.Ltd.
Serifali Mh, Bayraktar Bulvari, Kible Sk,
No: 29 - 34775 Umraniye
Istanbul - TURKIYE
Tel: +90 216 314 54 54
info@temastechnology.com

USA

Temas Technology LLC
11417 Irving Park Rd, Suite No. B-9-4
Franklin Park, 60131-3882,
Illinois - USA
Tel: +1 630 489 6994
sales@temastechnology.com

www.temastechnology.com